

CHAPTER 13

FINGERING CHARTS

FLUTE FINGERING CHART

1. How to use the fingering chart:

- a. The areas that are darkened in indicate which keys are depressed.
- b. Refer to the diagrams below to see finger placement on the flute.
- c. Where alternate fingerings are shown, use whichever one is more comfortable and convenient.

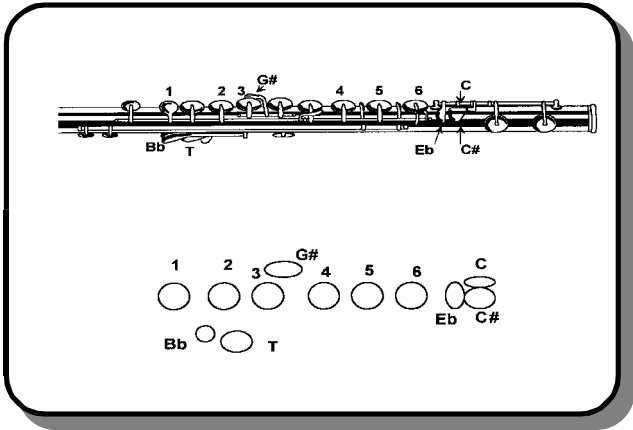

FLUTE FINGERING CHART

C	C#	Db	D
E	F	F#	Gb
G#	Ab	A	A#
Bb	B	C	C#

FLUTE FINGERING CHART



E F F# Gb G





G# Ab A A# Bb B



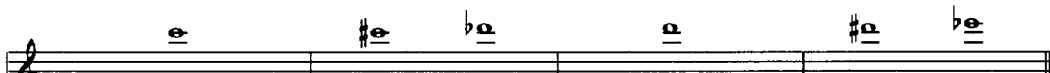

C C# Db D D# Eb



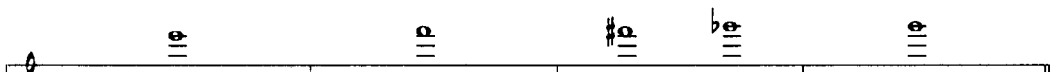

E F F# Gb G



CLARINET FINGERING CHART

CLARINET FINGERING CHART

1. How to use the fingering chart:
 - a. The areas that are darkened in indicate which keys are depressed.
 - b. Refer to the diagrams below to see finger placement on the clarinet.
 - c. Where alternate fingerings are shown, use whichever one is more comfortable and convenient.

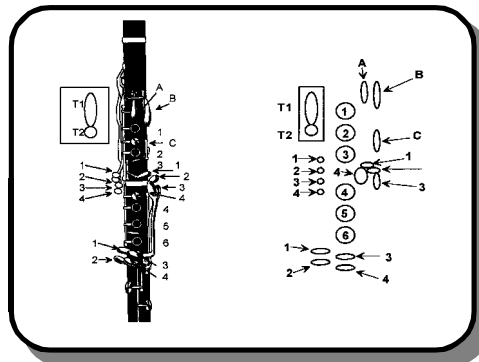

CLARINET FINGERING CHART - 1

 E F F# Gb G G# Ab A
 Fingering diagrams for notes E, F, F# Gb, G, G# Ab, and A.
 A# Bb B B C C# Db D D# Eb
 Fingering diagrams for notes A# Bb, B, B, C, C# Db, D, and D# Eb.
 D# Eb E F F# Gb G G# Ab
 Fingering diagrams for notes D# Eb, E, F, F# Gb, G, and G# Ab.

CLARINET FINGERING CHART - 2

This chart displays the fingering for various notes on a clarinet. Each note is represented by a musical staff with a note head and a corresponding fingering diagram below it. The diagrams use circles to indicate which fingers are placed on which keys. The notes are arranged in three rows:

- Row 1:** A, A# Bb, B, C, C# Db, C# Db, D
- Row 2:** D# Eb, E, F, F# Gb, F# Gb, G, G# Ab
- Row 3:** A, A# Bb, A# Bb, B, C, C# Db, D

Some notes have alternative fingerings indicated by the word "or" between two diagrams.

BASS CLARINET FINGERING CHART - 1

This chart displays the fingering for various notes on a bass clarinet. Each note is represented by a musical staff with a note head and a corresponding fingering diagram below it. The diagrams use circles to indicate which fingers are placed on which keys. The notes are arranged in three rows:

- Row 1:** A, Bb, B, C, C# Db, D, D# Eb
- Row 2:** D# Eb, E, F, F# Gb, F# Gb, G, G# Ab
- Row 3:** D# Eb, D# Eb, E, F, F# Gb, F# Gb, G

BASS CLARINET FINGERING CHART - 2



G# Ab A A# Bb B C C# Db C# Db

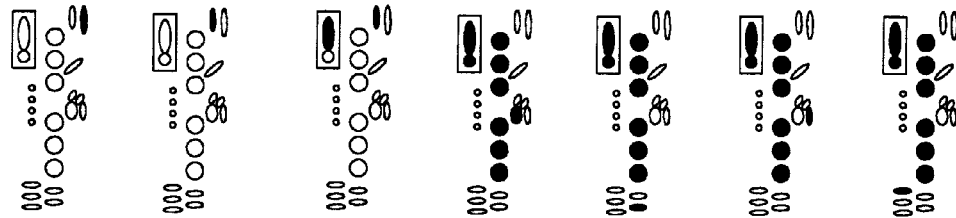

D D Eb E F F# Gb F# Gb G

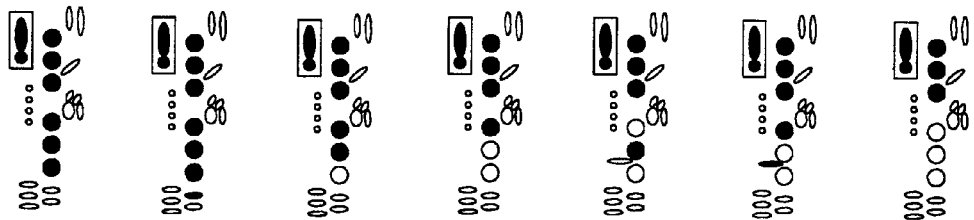

G# Ab A A# Bb A# Bb B C

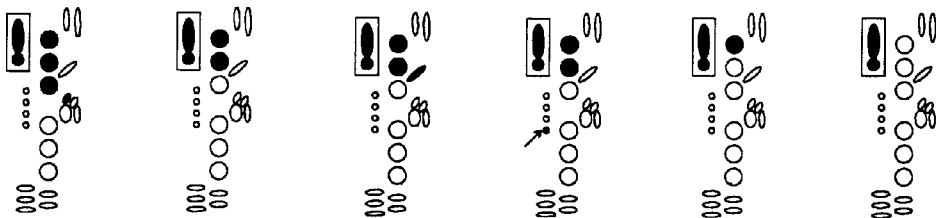

SAXOPHONE FINGERING CHART

SAXOPHONE FINGERING CHART

1. How to use the fingering chart:
 - a. The areas that are darkened in indicate which keys are depressed.
 - b. Refer to the diagrams below to see finger placement on the saxophone.
 - c. Where alternate fingerings are shown, use whichever one is more comfortable and convenient.

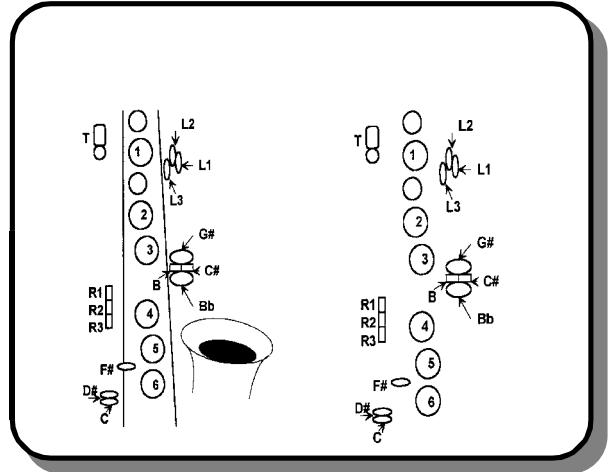

SAXOPHONE FINGERING CHART - 1

Alto, Tenor, Baritone

SAXOPHONE FINGERING CHART - 2

Alto, Tenor, Baritone



E	F	F# Gb	F# Gb	G	G# Ab
			 or		



A	A# Bb	A# Bb	B	C	C
	 or			 or	

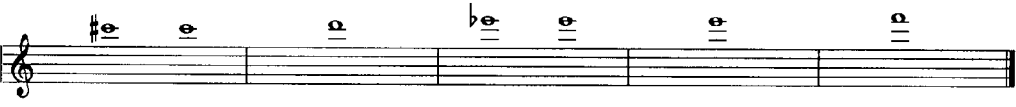

C#	Db	D	D# Eb	E	F

OBOE FINGERING CHART

OBOE FINGERING CHART

1. How to use the fingering chart:
 - a. The areas that are darkened in indicate which keys are depressed.
 - b. Refer to the diagrams below to see finger placement on the oboe. Notice that some fingerings call for only half the B key to be covered.
 - c. Where alternate fingerings are shown, use whichever one is more comfortable and convenient.

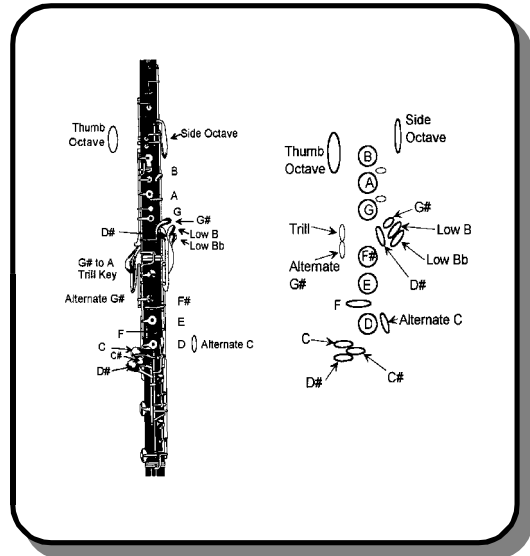

OBOE FINGERING CHART - 1

Musical notation and fingering diagrams for the first octave of the oboe:

- Line 1:** A# Bb, B, C, C# Db, D, D# Eb
- Line 2:** E, F, F (or F), F# Gb, G, G# Ab
- Line 3:** A, A# Bb, B, C, C# Db, D

Each note is accompanied by a diagram showing the placement of fingers (represented by black dots) on the oboe keys. The diagrams are arranged vertically to show the finger positions for each note.

OBOE FINGERING CHART - 2

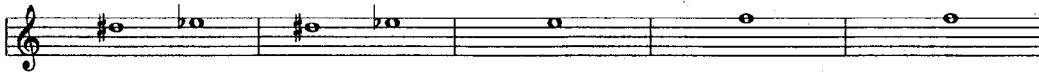

D# Eb



D# Eb



or

E

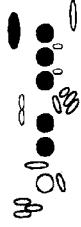

F



or

F

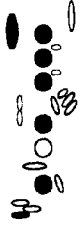

F# Gb

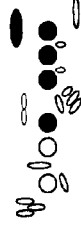

G



G# Ab



or

G# Ab



A

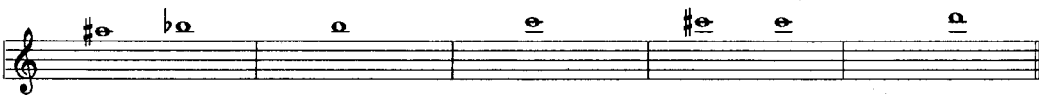
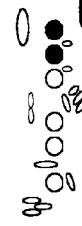

A# Bb



B



C



C# Db

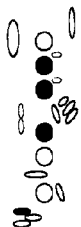

D



TRUMPET/CORNET FINGERING CHART

TRUMPET/CORNET FINGERING CHART

1. How to use the fingering chart:
 - a. The circles that are darkened in indicate which keys are depressed.
 - b. On a three valve Trumpet or Cornet, the valve nearest you while holding the instrument in the playing position is valve #1. The middle valve is valve #2 and the valve furthest away is valve #3.
 - c. On a valve instrument such as a Trumpet, Cornet, Tuba, Baritone or Alto Horn, the same combination of valves will produce several different tones. Care must be taken to ensure the correct tone is being played.

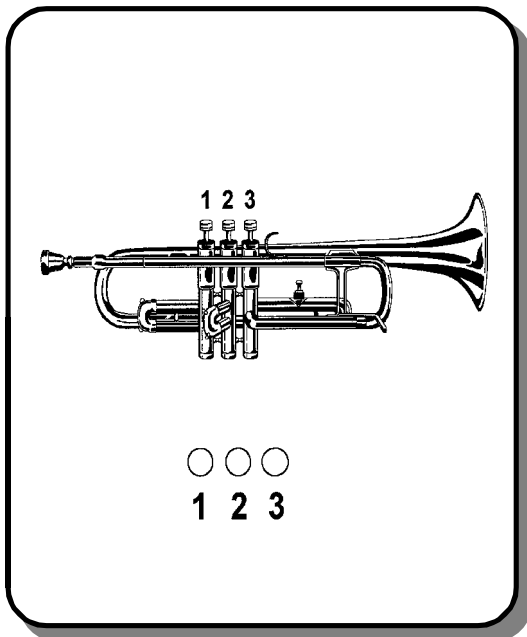

TRUMPET/CORNET FINGERING CHART

F#	G	G# Ab	A	A# Bb	B	C	C# Db
●●●	●○●	○●●	●●○	●○○	○●○	○○○	●●●
D	D# Eb	E	F	F# Gb	G	G# Ab	A
●○○	○●●	●●○	●○○	○●○	○○○	○●●	●●○
A# Bb	B	C	C# Db	D	D# Eb	E	F
●○○	○●○	○○○	●●○	●○○	○●○	○○○	●○○
F# Gb	G	G# Ab	A	A# Bb	B	C	
○●○	○○○	○●●	●●○	●○○	○●○	○○○	

FRENCH HORN FINGERING CHART

FRENCH HORN FINGERING CHART

1. How to use the fingering chart:
 - a. The circles that are darkened in indicate which valves are depressed.
 - b. On a three valve horn, the valve nearest you while holding the instrument (or the one you place your index finger on) is valve #1. The middle valve is valve #2 and the valve furthest away is valve #3. The French Horn is played with the left hand.
 - c. On a valve instrument such as a French Horn, the same combination of valves will produce several different tones. Care must be taken to ensure the correct tone is being played.

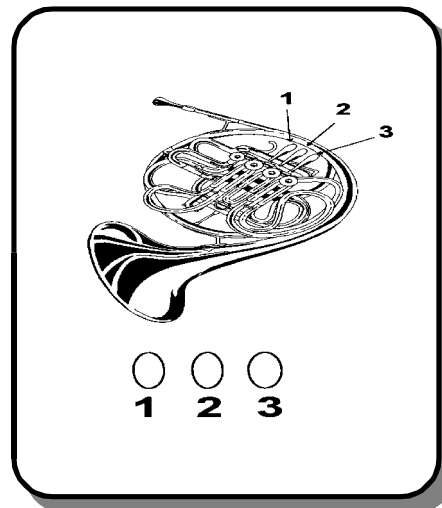

FRENCH HORN FINGERING CHART (Single "F" Horn)

0 ● ●	● ● 0	● 0 0	0 ● 0	0 0 0	● ● 0	● 0 0	0 ● 0
0 0 0	● 0 0	0 ● 0	0 0 0	0 ● ●	● ● 0	● 0 0	
0 ● 0	0 0 0	0 ● 0	0 0 0	0 ● 0	0 0 0	● 0 0	
0 ● ●	0 0 0	0 ● ●	● ● 0	● 0 0	0 ● 0	0 0 0	

FRENCH HORN FINGERING CHART (Single "Bb" Horn)

G# Ab	A	A# Bb	B	C	C# Db	D	D# Eb

--	--	--	--	--	--	--	--

E	F	F# Gb	G	G# Ab	A	A# Bb

		or (1-2)	or (1)			

B	C	C# Db	D	D# Eb	E	F

--	--	--	--	--	--	--

F# Gb	G	G# Ab	A	A# Bb	B	C

--	--	--	--	--	--	--

BARITONE FINGERING CHART

BARITONE FINGERING CHART

1. How to use the fingering chart:
 - a. The circles that are darkened in indicate which valves are depressed.
 - b. On a three valve Tuba, Baritone and Alto Horn, the valve nearest you while holding the instrument (or the one you place your index finger on) in the playing position is valve #1. The middle valve is valve #2 and the valve furthest away is valve #3.
 - c. On a valve instrument such as a Trumpet, Cornet, Tuba, Baritone or Alto Horn, the same combination of valves will produce several different tones. Care must be taken to ensure the correct tone is being played.

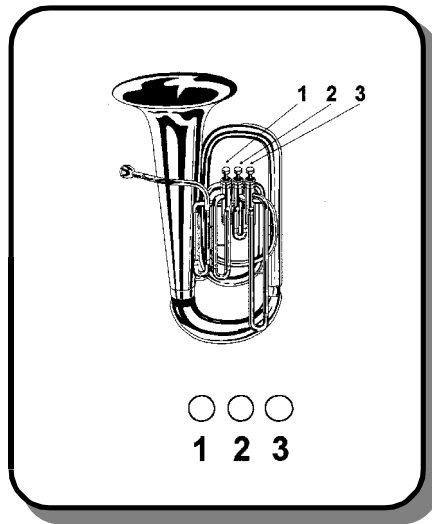



BARITONE (B.C.) FINGERING CHART

 F ● ○ ●	 G ● ● ○	 G# Ab ● ○ ○	 A ○ ● ○	 A# Bb ○ ○ ○	 B ● ● ●
 C ● ● ●	 C# Db ○ ● ●	 D ● ● ○	 D# Eb ● ○ ○	 E ○ ● ○	 F ○ ○ ○
 F# Gb ○ ● ●	 G ● ● ○	 G# Ab ● ○ ○	 A ○ ● ○	 A# Bb ○ ○ ○	 B ● ● ●
 C ● ○ ○	 C# Db ○ ● ○	 D ○ ○ ○	 D# Eb ● ○ ○	 E ○ ● ○	 F ○ ○ ○

BARITONE (T.C.) FINGERING CHART

G A A# Bb B C C# Db
●○○ ●●○ ●○○ ○●○ ○○○ ●●●

D D# Eb E F F# Gb G
●○○ ○●● ●●○ ●○○ ○●○ ○○○

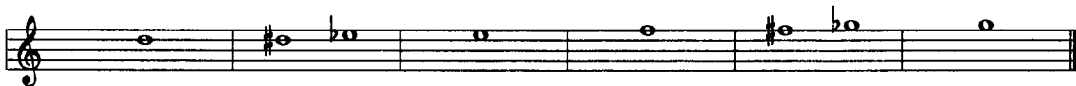

G# Ab A A# Bb B C C# Db
○●● ●●○ ●○○ ○●○ ○○○ ●●○

D D# Eb E F F# Gb G
●○○ ○●○ ○○○ ●○○ ○●○ ○○○

TUBA FINGERING CHART

TUBA FINGERING CHART

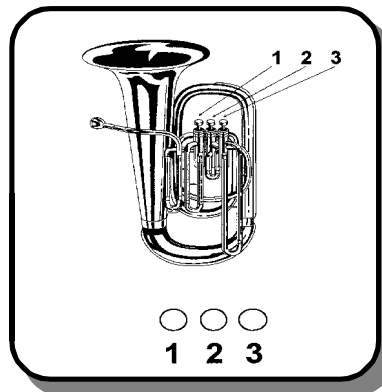



1. How to use the fingering chart:
 - a. The circles that are darkened in indicate which valves are depressed.
 - b. On a three valve Tuba, Baritone and Alto Horn, the valve nearest you while holding the instrument (or the one you place your index finger on) in the playing position is valve #1. The middle valve is valve #2 and the valve furthest away is valve #3.
 - c. On a valve instrument such as a Trumpet, Cornet, Tuba, Baritone or Alto Horn, the same combination of valves will produce several different tones. Care must be taken to ensure the correct tone is being played.





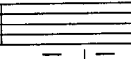

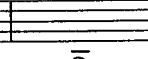
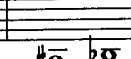

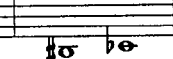
TUBA (Bb) FINGERING CHART

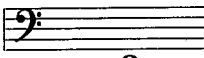
Bass clef	E	F	F# Gb	G	G# Ab	A	A# Bb	B
	●●●	●○●	○●●	●●○	●○○	○●○	○○○	●●●
Bass clef	C	C# Db	D	D# Eb	E	F	F# Gb	G
	●○○	○●●	●●○	●○○	○●○	○○○	○●●	●●○
Bass clef	G# Ab	A	A# Bb	B	C	C# Db	D	D# Eb
	●○○	○●○	○○○	●●○	●○○	○●○	○○○	●○○
Bass clef	E	F	F# Gb	G	G# Ab	A	A# Bb	
	○●○	○○○	○●●	●○○	●○○	○●○	○○○	

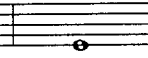
TUBA (Eb) FINGERING CHART

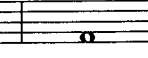
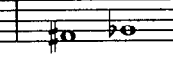
						
A	A# Bb	B	C	C# Db	D	D# Eb
●●●	●○○	○○●	●●○	●○○	○○●	○○○

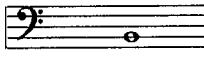
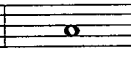
						
E	F	F# Gb	G	G# Ab	A	A# Bb
●●●	●○○	○○●	●●○	●○○	○○●	○○○

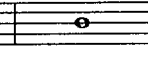
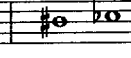
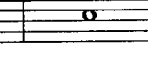
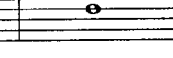
						
B	C	C# Db	D	D# Eb	E	F
○○●	●●○	●○○	○○●	○○○	●●○	●○○

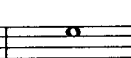
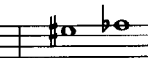
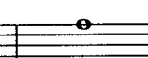
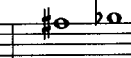
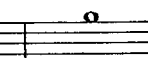
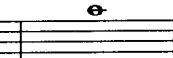
						
F# Gb	G	G# Ab	A	A# Bb	B	C
○○○	○○○	●○○	○○●	○○○	○○●	●○○



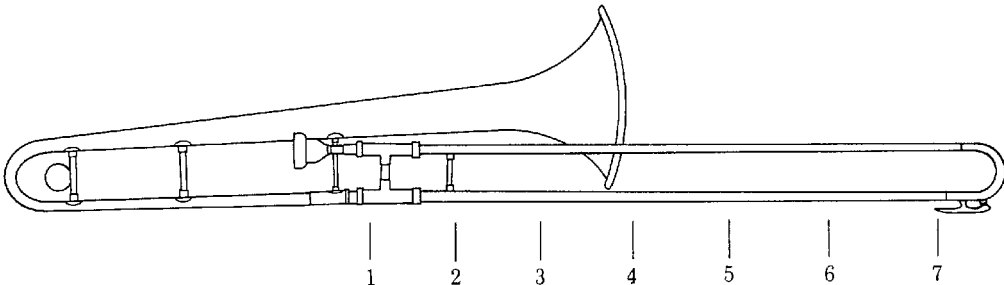

TROMBONE ELEMENTARY FINGERING CHART

1. How to read the chart: Numbers indicate the slide position.

TROMBONE ELEMENTARY FINGERING CHART

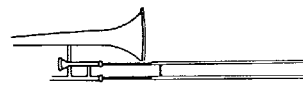
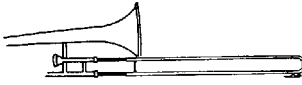
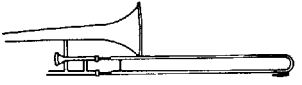
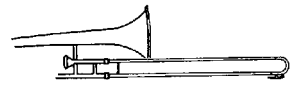

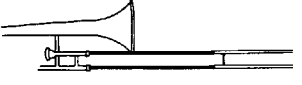
POSITIONS

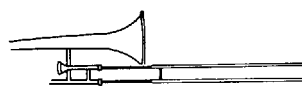
Slide Position	Notes	Diagram
4th Position	G	
3rd Position	G# - Ab	
2nd Position	A	
1st Position	A# - Bb	
7th Position	B	
6th Position	C	
5th Position	C# - Db	
4th Position	D	
3rd Position	D# - Eb	